



HONSEL

Umformtechnik GmbH

VNG 701
VNG 801

- Ⓛ D Bedienungsanleitung
- Ⓛ GB Instruction manual
- Ⓛ F Notice d'instruction
- Ⓛ E Guia de instrucciones
- Ⓛ I Istruzioni per l'uso
- Ⓛ NL Gebruiksaanwijzing
- Ⓛ S Bruksanvisning
- Ⓛ N Bruksanvisning
- Ⓛ DK Betjeningsvejledning
- Ⓛ SF Käyttöohje
- Ⓛ PL Instrukcja obsługi
- Ⓛ TR Kullanım El Kitabı





- (D) **Vor der Benutzung überprüfen**
(GB) **Check before use**
(F) **Verifier avant utilisation**
(E) **Antes de la utilizacion compruebe**
(I) **Verificare prima dell'uso**
(NL) **Controleren voor het gebruik**
(S) **Kontrollera före användadet**
(N) **Kontroller før bruk**
(DK) **Kontroller følgende før brug**
(SF) **Tarkista ennen käyttöä**
(PL) **Przed użyciem sprawdź**
(TR) **Kullanmadan önce kontrol edin**

(D) ÖLSTAND

(GB) OIL LEVER

(F) NIVEAU HUILE

(E) NIVEL DE ACEITE

(I) LIVELLO OLIO

(NL) OLIEPEIL

(S) OLJENIVÅ

(N) OLJENIVÅ

(DK) OLJESTAND

(SF) ÖLJYN MÄÄRÄ

(PL) POZIOM OLEJU

(TR) YAĞ SEVİYESİ

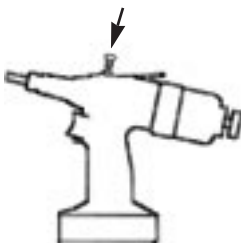

(D) BETRIEBSDRUCK

(GB) OPERATING PRESSURE

(F) PRESSION D'UTILISATION

(E) PRESSION DE UTILIZACION

(I) PRESSIONE DI UTILIZZO

(NL) LUCHTDRUK

(S) ARBETSTRYCK

(N) ARBEIDSTRYKK

(DK) ARBEJDSSTRYK

(SF) KÄYTTÖPAINE

(PL) CIŚNIENIE SPRĘŻONEGO POWIETRZA

(TR) ÇALIŞMA BASINCI



(D) ZUSTAND GEWINDEDORN

(GB) CONDITION OF THE MANDREL

(F) ETAT TIGE DE TRACTION

(E) ESTADO DEL MANDRIL

(I) STATU DELLE ASTA FILETTATA

(NL) STAAT VAN DE DRAADSTIFT

(S) DRAGDORN KONDITION

(N) RENE GJENGETOLK

(DK) GEVINDDORN TILSTAND

(SF) KIERREKARA ASENTO

(PL) STAN TRZPIENA



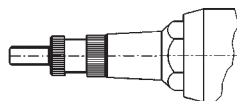





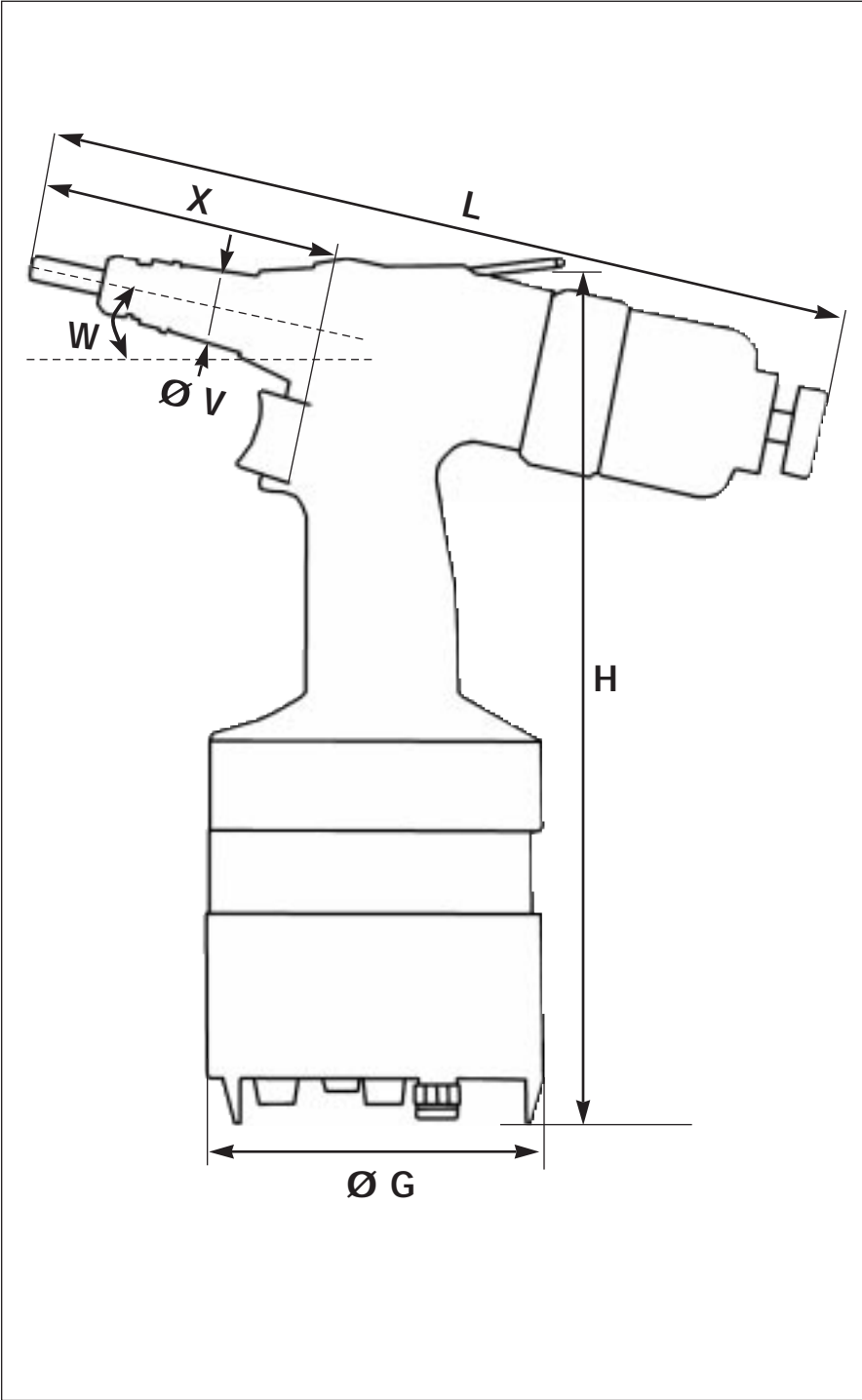

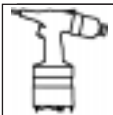





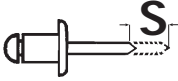

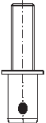
(TR) ÇENELERİN SİPLAMA

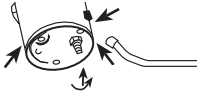



- D** – VERWENDEN SIE ORIGINALTEILE
– NEHMEN SIE KEINE REPARATUREN SELBST VOR
– BEI STÖRUNGEN NEHMEN SIE MIT IHREM HÄNDLER KONTAKT AUF
– ARBEITEN SIE NICHT BEI EINEM BETRIEBSDRUCK VON MEHR ALS 8 BAR
– RICHTEN SIE BEI DER BENUTZUNG DIESES WERKZEUG NIEMALS AUF PERSONEN
– TRAGEN SIE BEI DER BENUTZUNG EINE SCHUTZBRILLE
– TRAGEN SIE BEI DER BENUTZUNG GEHÖRSCHUTZ
- GB** – ONLY USE ORIGINAL PARTS
– DO NOT MAKE REPAIRS YOURSELF
– IN THE EVENT OF PROBLEMS, PLEASE CONTACT YOUR LOCAL DEALER
– DO NOT OPERATE AT A PRESSURE OF MORE THAN 8 BAR
– NEVER POINT THIS TOOL TOWARDS ANOTHER PERSON
– WEAR SAFETY GLASSES WHEN USING THIS TOOL
– WEAR EAR PROTECTORS WHEN USING THIS MACHINE
- F** – N'UTILISER QUE DES PIÈCES D'ORIGINES
– NE PAS EFFECTUER DE REPARATIONS VOUS MÊME
– EN CAS D'ANOMALIE, VEUILLER CONTACTER VOTRE DISTRIBUTEUR
– NE PAS UTILISER UNE PRESSION SUPERIEURE A 8 BAR
– NE DIRIGER JAMAIS CET OUTIL VERS UNE PERSONNE
– PORTEZ DES LUNETTES DE PROTECTION LORS DE L'UTILISATION
– PORTEZ UN CASQUE D'ISOLATION PHONIQUE PENDANT L'UTILISATION
- E** – UTILICE UNICAMENTE PIEZAS DE ORIGEN
– NO EFECTUE REPARACIONES USTED MISMO
– EN CASO DE ANOMALIA, PONGASE EN CONTACTO CON SU DISTRIBUIDO
– NO USE UNA PRESION DE UTILIZACION SUPERIOR A 8 BARES
– NO DIRIJA NUNCA ESTA HERRAMIENTA HACIA UNA PERSONA
– LLEVE GAFAS DE PROTECCION DURANTE LA UTILIZACION
– LLEVE UN CASCO DE AISLAMIENTO FONICO DURANTE LA UTILIZACION
- I** – UTILIZZARE UNICAMENTE RICAMBII ORIGINALI
– NON PUNTARE MAI L'UTENSILE CONTRO TERZI
– IN CASO DI ANOMALIA CONSULTARE IL VOSTRO DISTRIBUTORE
– NON USARE MAI UNA PRESSIONE D'UTILIZO SUPERIORE A 8 BAR
– NON PUNTARE MAI LO STRUMENTO CONTRO UNA PERSONA
– METTERE OCCHIALI DI PROTEZIONE DURANTE L'UTILIZO
- NL** – ALLEEN ORGINELE ONDERDELEN GEBRUIKEN
– ZELF GEEN REPARATIES UITVOEREN
– BIJ STORINGEN CONTACT OPNEMEN MET UW LEVERANCIER
– GEEN DRUK HOGER DAN 8 BAR GEBRUIKEN
– DIT GEREEDSCHAP NOOIT OP IEMAND RICHTEN
– TIJDEN GEBRUIK GEHOOR- EN GEZICHTS-BESCHERMING DRAGEN
- S** – ANVÄND ENDAST ORIGINALDELAR
– REPARERA EJ SJÄLV
– VID EV. DRIFTSTÖRNINGAR KONTAKTA DIN LEVERANTÖR
– ANVÄND EJ HÖGRE TRYCK ÄN 8 BAR
– RIKTA ALDRIG VERKTÖGET MOT ANDRA PERSONER
– ANVÄND SKYDDSGLASÖGON
– ANVÄND HÖRSELSKYDD
- N** – KONTROLLER TRYKKLUFTSLANGEN OG KOPLINGEN FØR BRUK
– ARBEIDSTRYKKET MÅ IKKE OVERSTIGE 8 BAR
– KOBLE FRA TRYKKLUFTSLANGEN FØR DU UTFØRER NOE ARBEIDE PÅ SELVE VERKTØYET
– VED PROBLEMER, KONTAKT SELGER
– SIKT ALDRIG MED VERKTØYET PÅ ANDRE MENNESKER
– BRUK VERNEBRILLER OG VED BEHOV HØRSELVERN
– BRUK VERKTØYET KUN FOR DET RIKTIGE FORMÅLET
- DK** – ANVEND KUN ORIGINALDELE
– REPARER ALDRIG SELV VÆRKTØJET
– KONTAKT DERES LEVERANDØR VED VÆRKTØJSPROBLEMER
– VÆRKTØJET MÅ IKKE BRUGES VED MERE END 8 BAR TRYK
– PEG ALDRIG VÆRKTØJET MOD EN ANDEN PERSON
– BÆR ALTID BESKYTTELSBRILLER UNDER ARBEJDET
– BÆR ALTID HØREVERN UNDER ARBEJDET
- SF** – KÄYTA VAIN ALKUPERÄISIÄ VARAOSIA
– ÄLÄ TEE ITSE KORJAUSTÖITÄ
– OTA ONGELMATAPAUKSISSA YHTEYTTÄ LAITTEEN MYYNNEESEEN LIIKKEESEEN
– ÄLÄ KÄYTÄ YLI 8 BARIN PAINETTA
– LAITTEELLA EI SAA OSOITTA MUUTA IHMISIÄ KOHTI
– KÄYTÄ SUOJALASEJA JA MAHDOLLISESTI MYÖS KUULOSUOJAMIA
- PL** – STOSOWAĆ WYŁĄCZNIE ORIGINALNE CZĘŚCI ZAMIENNE
– NIE PODEJMOWAĆ SAMODZIELNYCH REPARATUR
– W PRZYPADKU USTEREK SKONTAKTOWAĆ SIĘ Z PUNKTEM SPRZEDAŻY
– NIE STOSOWAĆ SPRĘŻONEGO POWIETRZA POWYŻEJ 8 BAR
– NIGDY NIE KIEROWAĆ NARZĘDZIA W STRONĘ OSÓB
– PODCZAS PRACY NOSIĆ OKULARY OCHRONNE
– STOSOWAĆ ŚRODKI OCHRONY SŁUCHU
- TR** – SADECE ORJİNAL PARÇA KULLANIN
– KENDİNİZ TAMİRAT YAPMAYIN
– SORUN HALİNDE BÖLGE BAYİNİZLE TEMAS KURUN
– 8 BARDAN YÜKSEK BASINÇTA ÇALIŞTIRMAYINIZ
– BU ALETİ BAŞKA BİR ŞAHSA DOĞRU TUTMAYINIZ
– BU ALETİ KULLANIRKEN EMNİYET GÖZLÜĞÜ TAKINIZ
– BU MAKİNEYİ KULLANIRKENKULAK KORUYUCUSU KULLANIN



					
	VNG 701	VNG 801		VNG 701	VNG 801
 P	5 – 7 bar	5 – 7 bar	X	78	58
 F	15.500 N	29.000 N	Ø G	90	90
 S	max. 6 mm	max. 7 mm	 Dmin – Dmax	M 3 – M 6	M 4 – M 10
	6,0 l	7,5 l	 dmax	M 4 – M 6	M 4 – M 8
	2,4 kg	2,6 kg			
L	275 mm	280 mm		1/4 "	1/4 "
H	270 mm	300 mm		4,5 E/50 C	4,5 E/50 C
 W	12°	12°		89 dB(A)	70 dB(A)
Ø V	24,0	26,0		0,59 m/s ²	0,61 m/s ²



SW 20
SW 24



SW 24



SW 10
SW 12





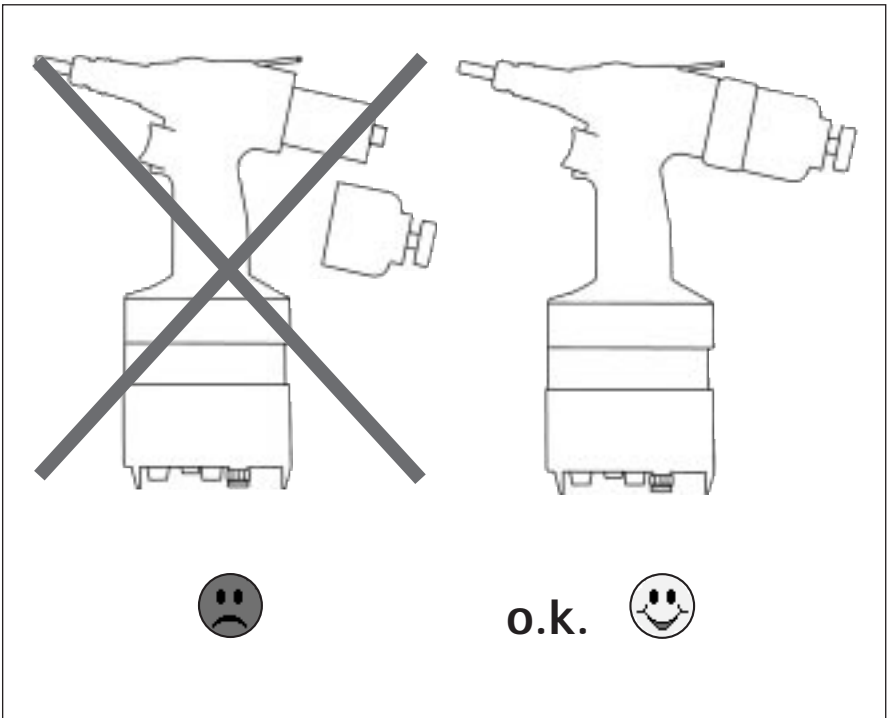
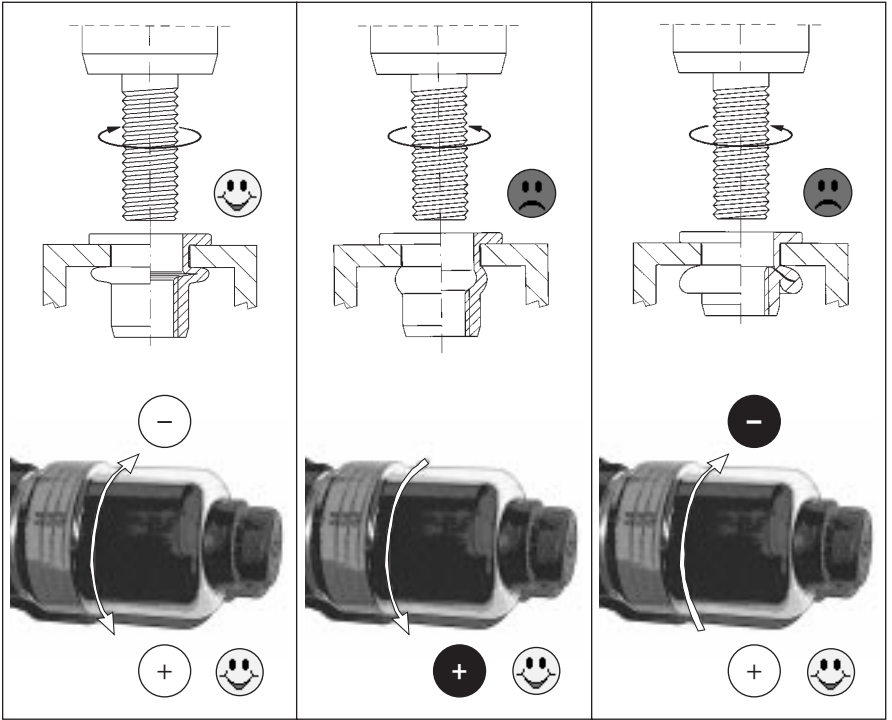

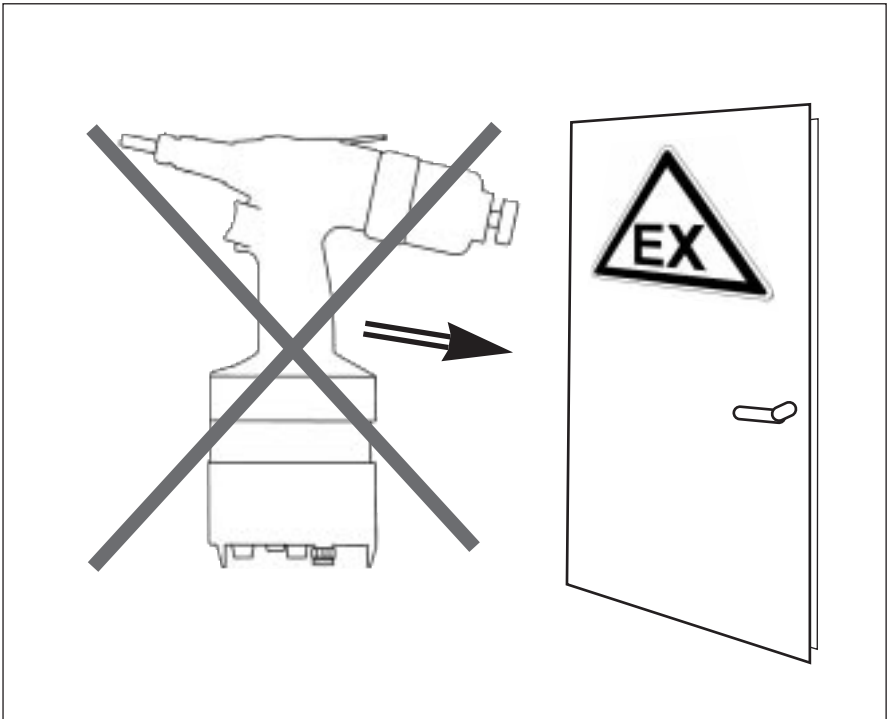
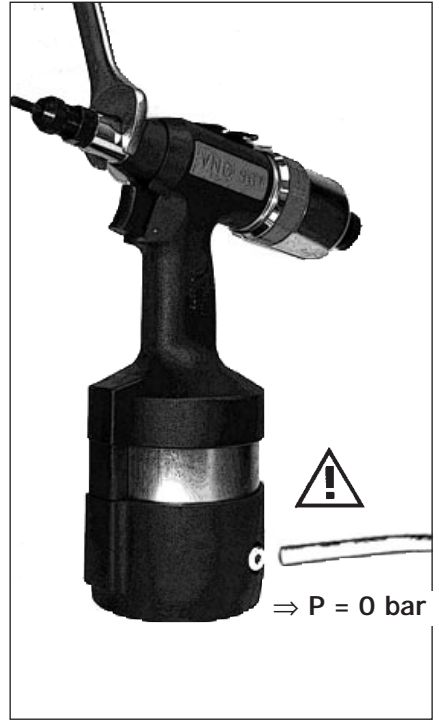
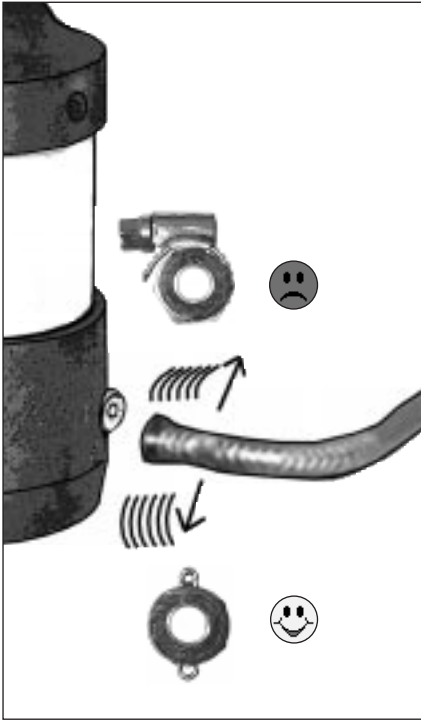

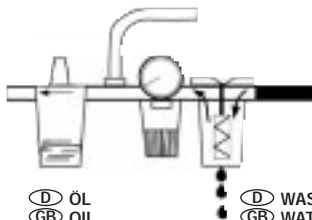
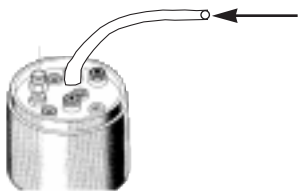

(D) TROCKENE LUFT

(GB) DRY AIR

(F) AIR SEC

(E) AIRE SECO

(I) ARIA SECCA

(NL) DROGE LUCHT

(S) TORR LUFT

(N) TØRR LUFT

(DK) TØR LUFT

(SF) KUIVAA ILMAA

(PL) SUCHE, SPRĘŻONE POWIETRZE

(TR) KURU HAVA

(D) ÖL

(GB) OIL

(F) HUILE

(E) ACIETE

(I) OLIO

(NL) OLIE

(S) OLJA

(N) OLJE

(DK) OLIE

(SF) OLJYA

(PL) OLEJ

(TR) YAĞ

(D) WASSER

(GB) WATER

(F) EAU

(E) AQUA

(I) AQUA

(NL) WATER

(S) VANN

(N) VANN

(DK) VAND

(SF) VESI

(PL) WODA

(TR) SU

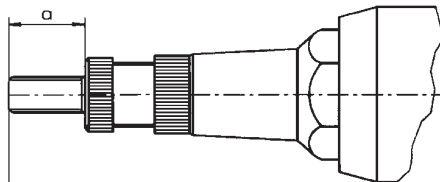
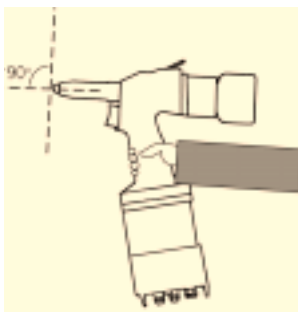

$$a - b = s$$

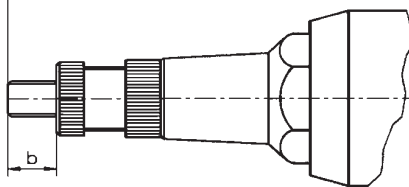

VNG 701
VNG 801

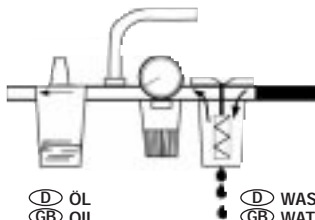
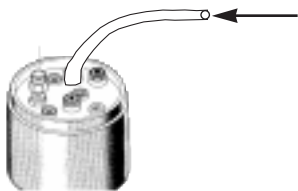

(D) TROCKENE LUFT

(GB) DRY AIR

(F) AIR SEC

(E) AIRE SECO

(I) ARIA SECCA

(NL) DROGE LUCHT

(S) TORR LUFT

(N) TØRR LUFT

(DK) TØR LUFT

(SF) KUIVAA ILMAA

(PL) SUCHE, SPRĘŻONE POWIETRZE

(TR) KURU HAVA

(D) ÖL

(GB) OIL

(F) HUILE

(E) ACIETE

(I) OLIO

(NL) OLIE

(S) OLJA

(N) OLJE

(DK) OLIE

(SF) OLJYA

(PL) OLEJ

(TR) YAĞ

(D) WASSER

(GB) WATER

(F) EAU

(E) AQUA

(I) AQUA

(NL) WATER

(S) VANN

(N) VANN

(DK) VAND

(SF) VESI

(PL) WODA

(TR) SU

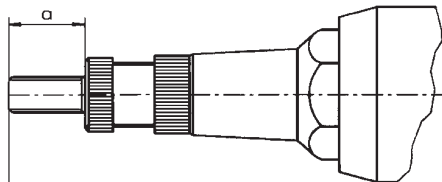
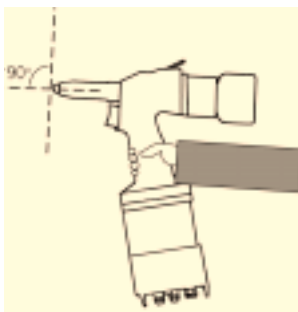

$$a - b = s$$

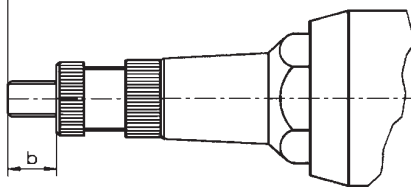
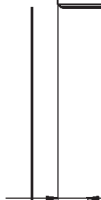

VNG 701
VNG 801

VNG 701
VNG 801

Deutschland:

VVG

Befestigungstechnik
GmbH & Co.

Haberstraße 29

24537 Neumünster

Postfach 2752

24517 Neumünster

Tel. +49 (0) 43 21/96 7171

Fax +49 (0) 43 21/96 7196

Frankreich:

Alfred Honsel s.a.r.l.

20, rue du Lhotaud

Boîte Postale 1

F-25560 Frasne

Tel. +33 (3) 381498946

Fax +33 (3) 381498947

VVG France s.a.r.l.

20, rue du Lhotaud

Boîte Postale 1

F-25560 Frasne

Tel. +33 (3) 381498900

Fax +33 (3) 381498699

Belgien:

Combori N.V.

Blancefloerlaan 181

B-2050 Antwerpen

Tel. +32 (0) 3/2101211

Fax +32 (0) 3/2195804

Dänemark:

OJD Trading ApS

Lerbaekvej 16 + 18

DK-2680 Solroed Strand

Tel. (+45) 53 14 14 28

Fax (+45) 53 14 64 78

e-mail: ojd@ojd.dk

Finnland:

Oy Mercantile AB

Mercantile Pultti

Hakkilankaari 2

SF-01380 Vantaa

Tel. +358 9 34 501

Fax +358 9 873 3662

Niederlande:

Borstlap B.V.

Postbus 50 34

NL-5004 EA Tilburg

Tel. +31 (0) 13/5941234

Fax +31 (0) 13/5941212

Norwegen:

Tingstad AS

Stalfjæra 17

Kalbakken

Postboks 83

N-0902 Oslo

Tel. +47/22169400

Fax +47/22164583

Italien:

Unicom SRL

Rappresentanze Industriali

Via Arona, 37

I-10145 Torino

Tel. +39 (0) 117716090

Fax +39 (0) 117716127

Polen:

PHU Marsel BIS

Marek Chlebosz

UL. Soldka 16 d

PL-80299 Gdansk

Tel. +48 (0) 58-5500700

Fax +48 (0) 58-5500700

Schweiz:

Airproduct AG

Bremgartenstrasse 31

CH-8966 Oberwil-Lieli

Tel. +41 (0) 566339633

Fax +41 (0) 566339638

Türkei:

Günmak

Kompresör ve Makina

Sanayi ve Ticaret A.S.

Perpa Ticaret Merkezi Kat. 9

No. 1354

TR-80270 Okmeydanı-İstanbul

Tel. +90 (0) 2122215510

Fax +90 (0) 2122215509

Südafrika:

Hyper Pneumatics

Postbox 10499

Linton Grange

ZA-6015 Port Elizabeth

Tel. +27 (0) 413604686

Fax +27 (0) 413606255

USA:

Global Techsol

2400 E. Main Street

Suite 103 # 311

USA-St. Charles

IL 60175

Tel. +1 (630) 2581879

Fax +1 (630) 5131861



HONSEL

Umformtechnik GmbH

Postfach 1262/1263 · 58718 Fröndenbergr/Ruhr

fon Verkauf Inland +49 (0) 2373 755 300

fon Verkauf Ausland +49 (0) 2373 755 400

fax +49 (0) 2373 755 600

email info@honsel.de

web <http://www.honsel.de>